

JFET VHF/UHF Amplifiers

N-Channel — Depletion

BF245A
BF245B

MAXIMUM RATINGS

| Rating | Symbol | Value | Unit |
|--|------------|-------------|-------------|
| Drain-Source Voltage | V_{DS} | ± 30 | Vdc |
| Drain-Gate Voltage | V_{DG} | 30 | Vdc |
| Gate-Source Voltage | V_{GS} | 30 | Vdc |
| Drain Current | I_D | 100 | mAdc |
| Forward Gate Current | $I_{G(f)}$ | 10 | mAdc |
| Total Device Dissipation @ $T_A = 25^\circ\text{C}$ Derate above 25°C | P_D | 350 2.8 | mW mW/°C |
| Storage Channel Temperature Range | T_{stg} | -65 to +150 | °C |

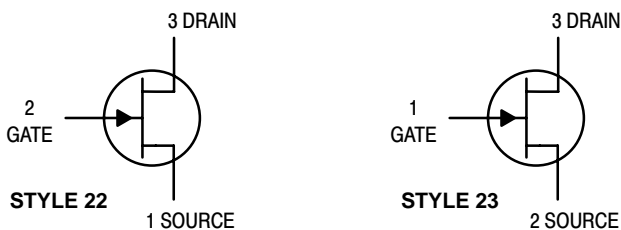
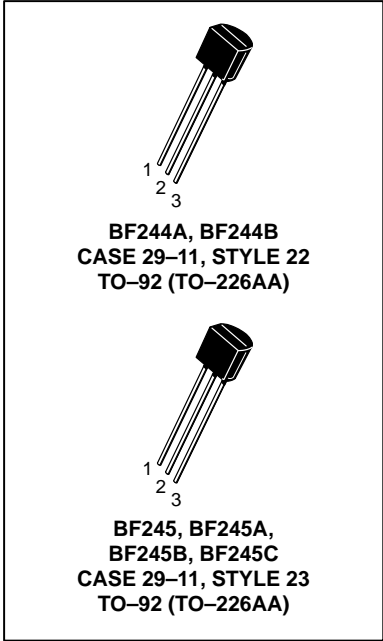

ELECTRICAL CHARACTERISTICS ($T_A = 25^\circ\text{C}$ unless otherwise noted)

| Characteristic | Symbol | Min | Typ | Max | Unit |
|----------------|--------|-----|-----|-----|------|
|----------------|--------|-----|-----|-----|------|

OFF CHARACTERISTICS

| | | | | | |
|---|---------------|---|------------------|--------------------------|------|
| Gate-Source Breakdown Voltage ($I_G = 1.0 \mu\text{Adc}$, $V_{DS} = 0$) | $V_{(BR)GSS}$ | 30 | — | — | Vdc |
| Gate-Source ($V_{DS} = 15 \text{ Vdc}$, $I_D = 200 \mu\text{Adc}$) | V_{GS} | BF245(1) 0.4 BF245A, BF244A(2) 0.4 BF245B, BF244B 1.6 BF245C 3.2 | — — — — | 7.5 2.2 3.8 7.5 | Vdc |
| Gate-Source Cutoff Voltage ($V_{DS} = 15 \text{ Vdc}$, $I_D = 10 \text{ nAdc}$) | $V_{GS(off)}$ | -0.5 | — | -8.0 | Vdc |
| Gate Reverse Current ($V_{GS} = 20 \text{ Vdc}$, $V_{DS} = 0$) | I_{GSS} | — | — | 5.0 | nAdc |

ON CHARACTERISTICS

| | | | | | |
|---|-----------|--|------------------|-----------------------|------|
| Zero-Gate-Voltage Drain Current ($V_{DS} = 15 \text{ Vdc}$, $V_{GS} = 0$) | I_{DSS} | BF245(1) 2.0 BF245A, BF244A(2) 2.0 BF245B, BF244B 6.0 BF245C 12 | — — — — | 25 6.5 15 25 | mAdc |
|---|-----------|--|------------------|-----------------------|------|

1. On orders against the BF245, any or all subgroups might be shipped.
2. On orders against the BF244A, any or all subgroups might be shipped.

BF245A BF245B

ELECTRICAL CHARACTERISTICS (T_A = 25°C unless otherwise noted) (Continued)

| Characteristic | | Symbol | Min | Typ | Max | Unit |
|-------------------------------------|---|---------------------|-----|-----|-----|-------|
| SMALL-SIGNAL CHARACTERISTICS | | | | | | |
| Forward Transfer Admittance | (V _{DS} = 15 Vdc, V _{GS} = 0, f = 1.0 kHz) | Y _{fs} | 3.0 | — | 6.5 | mmhos |
| Output Admittance | (V _{DS} = 15 Vdc, V _{GS} = 0, f = 1.0 kHz) | Y _{OS} | — | 40 | — | μmhos |
| Forward Transfer Admittance | (V _{DS} = 15 Vdc, V _{GS} = 0, f = 200 MHz) | Y _{fs} | — | 5.6 | — | mmhos |
| Reverse Transfer Admittance | (V _{DS} = 15 Vdc, V _{GS} = 0, f = 200 MHz) | Y _{rs} | — | 1.0 | — | mmhos |
| Input Capacitance | (V _{DS} = 20 Vdc, -V _{GS} = 1.0 Vdc) | C _{iss} | — | 3.0 | — | pF |
| Reverse Transfer Capacitance | (V _{DS} = 20 Vdc, -V _{GS} = 1.0 Vdc, f = 1.0 MHz) | C _{rss} | — | 0.7 | — | pF |
| Output Capacitance | (V _{DS} = 20 Vdc, -V _{GS} = 1.0 Vdc, f = 1.0 MHz) | C _{oss} | — | 0.9 | — | pF |
| Cut-off Frequency ⁽³⁾ | (V _{DS} = 15 Vdc, V _{GS} = 0) | F(Y _{fs}) | — | 700 | — | MHz |

3. The frequency at which g_{fs} is 0.7 of its value at 1 kHz.

COMMON SOURCE CHARACTERISTICS ADMITTANCE PARAMETERS (V_{DS} = 15 Vdc, T_{channel} = 25°C)

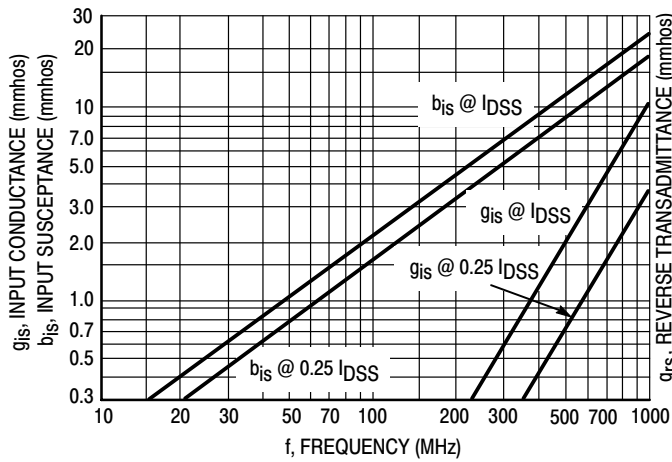

Figure 1. Input Admittance (y_{is})

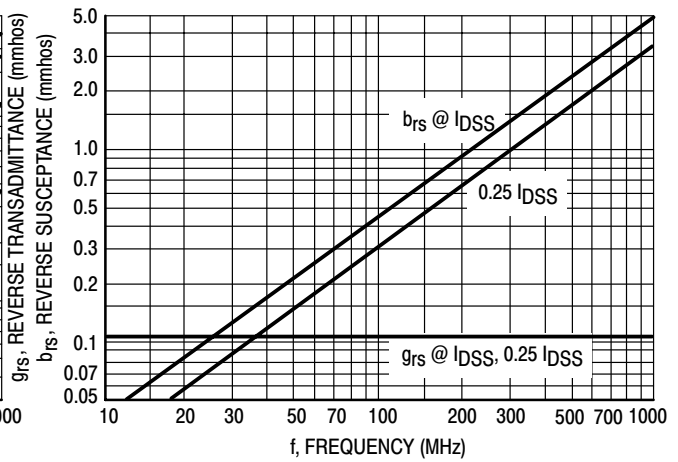

Figure 2. Reverse Transfer Admittance (y_{rs})

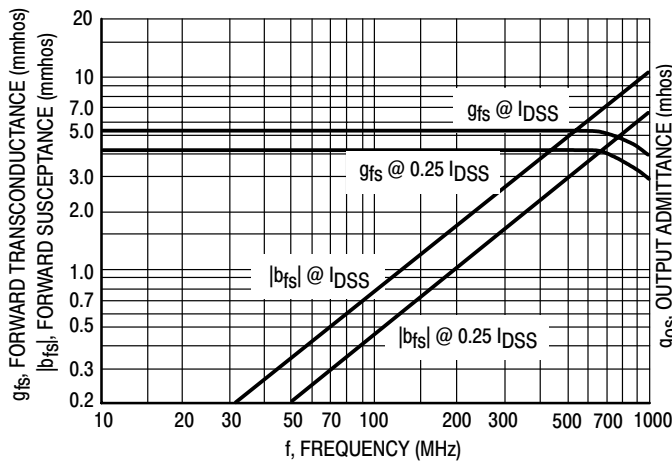

Figure 3. Forward Transadmittance (y_{fs})

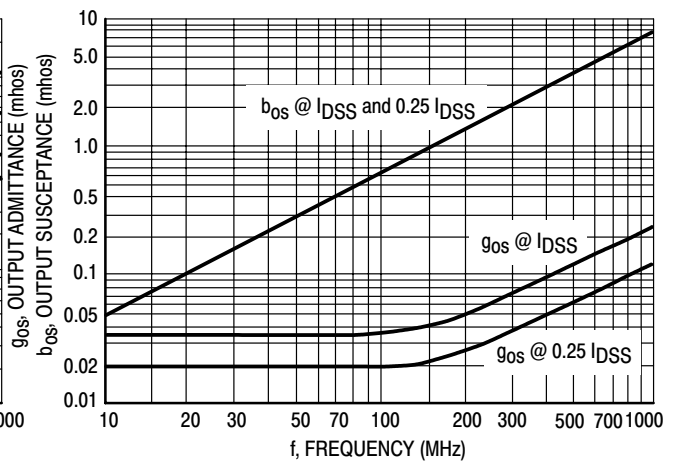

Figure 4. Output Admittance (y_{os})

BF245A BF245B

COMMON SOURCE CHARACTERISTICS S-PARAMETERS

($V_{DS} = 15 \text{ Vdc}$, $T_{\text{channel}} = 25^\circ\text{C}$, Data Points in MHz)

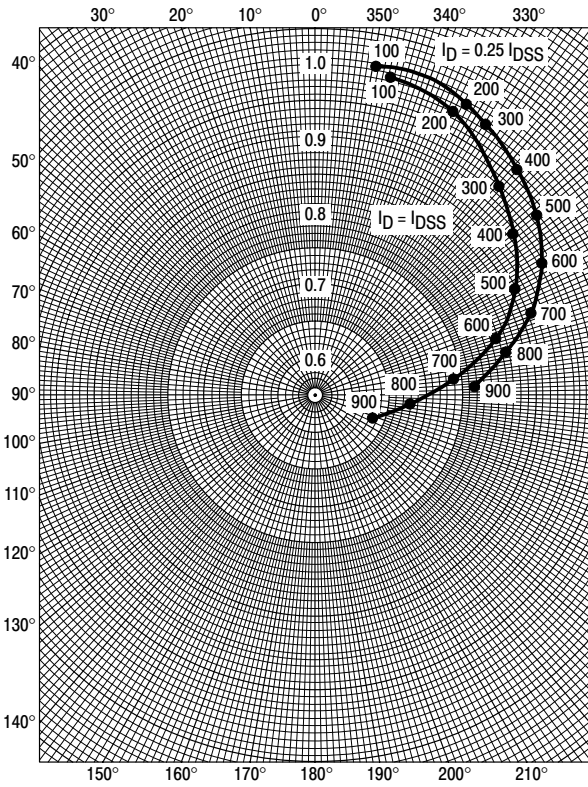

Figure 5. S_{11s}

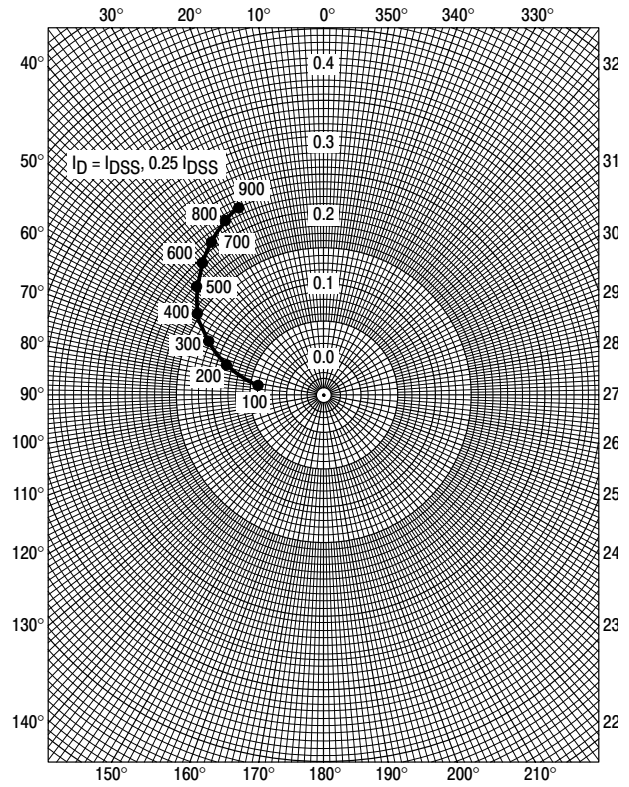

Figure 6. S_{12s}

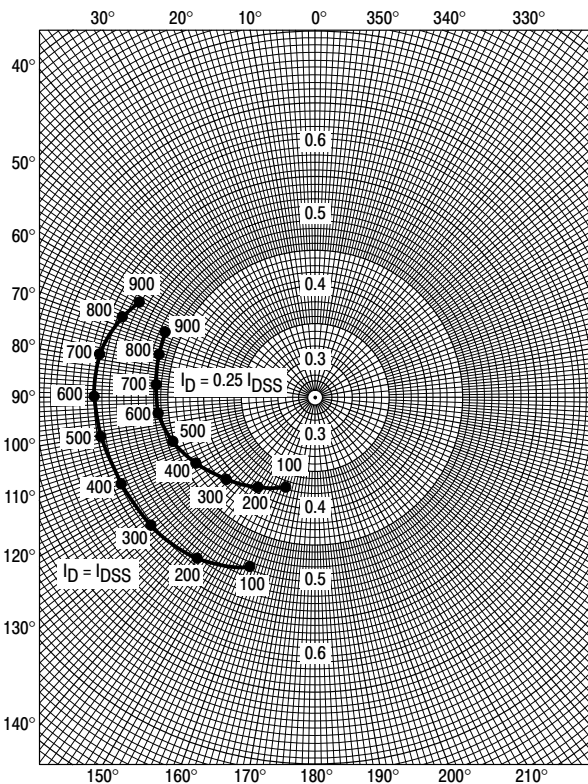

Figure 7. S_{21s}

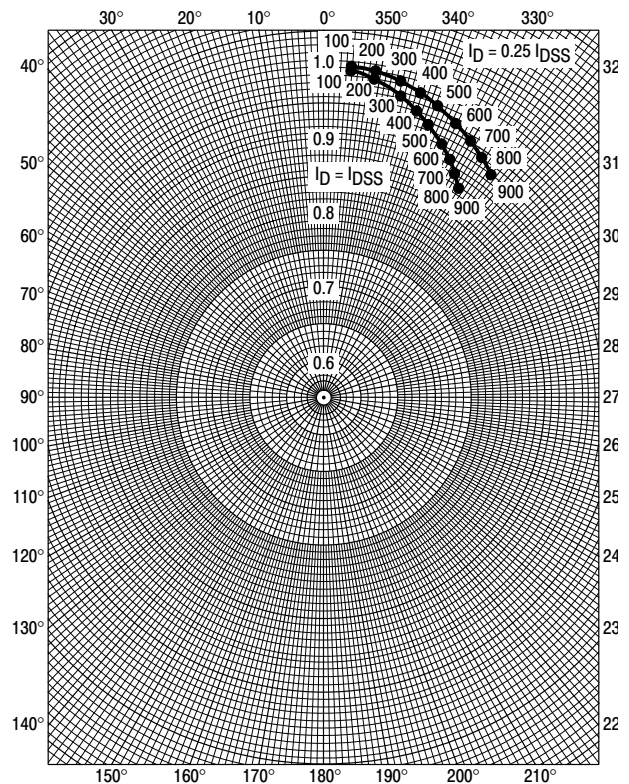

Figure 8. S_{22s}

BF245A BF245B

COMMON GATE CHARACTERISTICS ADMITTANCE PARAMETERS ($V_{DG} = 15 \text{ Vdc}$, $T_{\text{channel}} = 25^\circ\text{C}$)

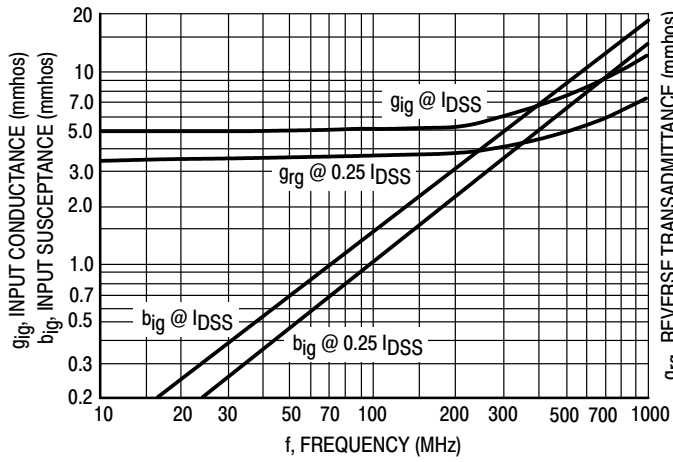

Figure 9. Input Admittance (y_{ig})

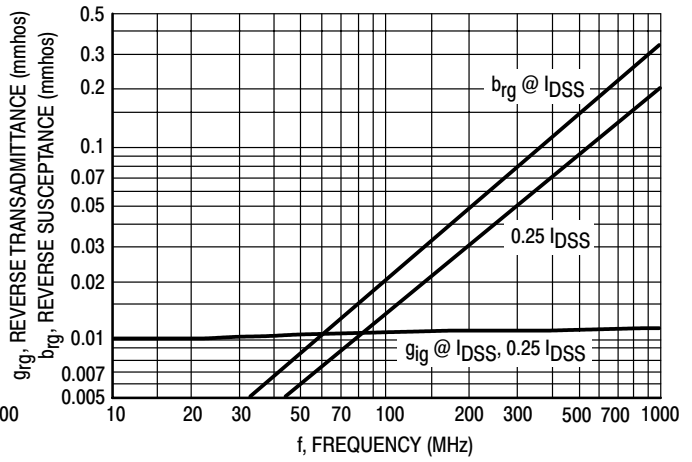

Figure 10. Reverse Transfer Admittance (y_{rg})

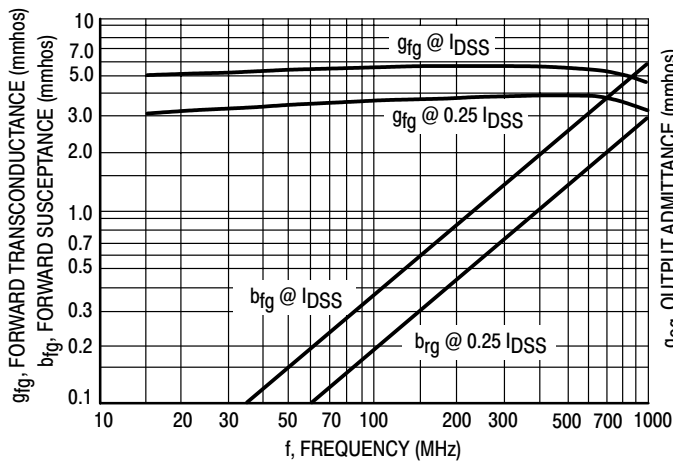

Figure 11. Forward Transfer Admittance (y_{fg})

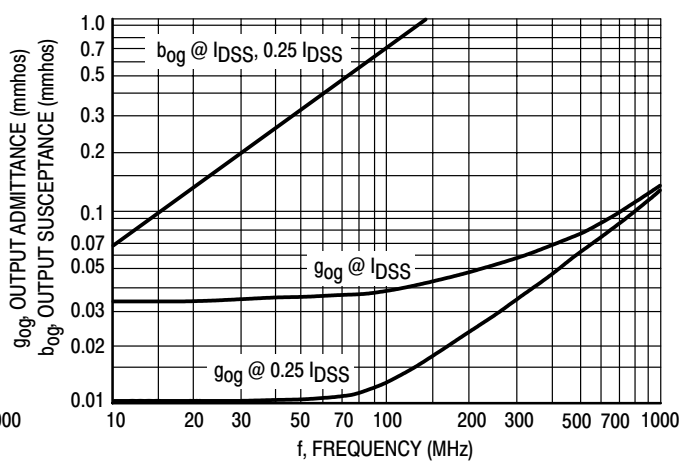

Figure 12. Output Admittance (y_{og})

COMMON GATE CHARACTERISTICS
S-PARAMETERS
 ($V_{DS} = 15 \text{ Vdc}$, $T_{\text{channel}} = 25^\circ\text{C}$, Data Points in MHz)

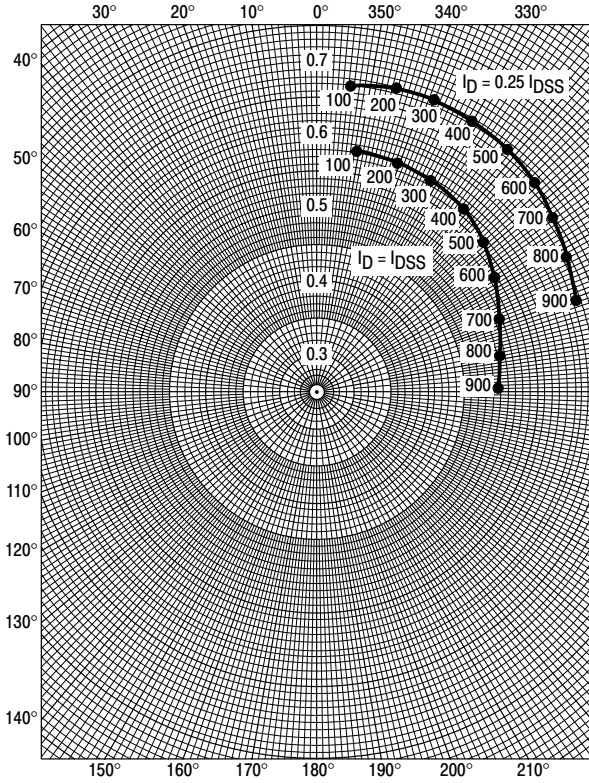

Figure 13. S_{11g}

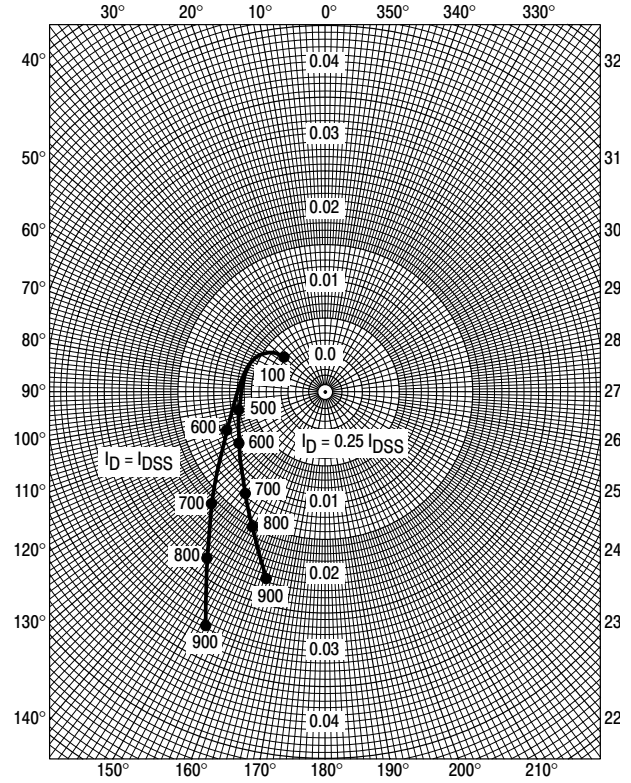

Figure 14. S_{12g}

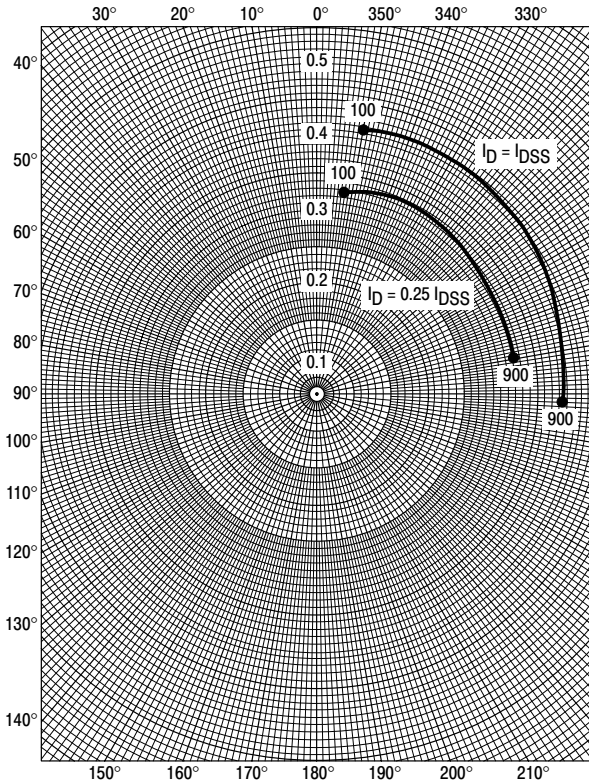

Figure 15. S_{21g}

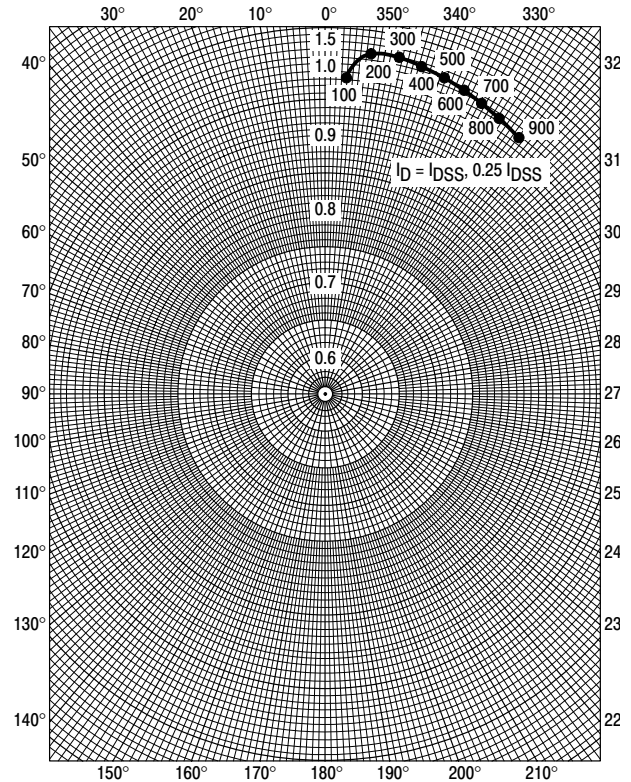
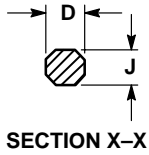
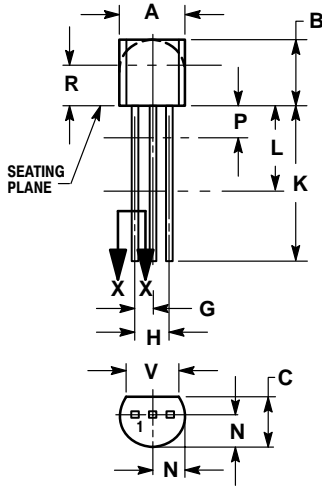

Figure 16. S_{22g}

BF245A BF245B

PACKAGE DIMENSIONS

TO-92 (TO-226)
CASE 29-11
ISSUE AL



NOTES:

1. DIMENSIONING AND TOLERANCING PER ANSI Y14.5M, 1982.
2. CONTROLLING DIMENSION: INCH.
3. CONTOUR OF PACKAGE BEYOND DIMENSION R IS UNCONTROLLED.
4. LEAD DIMENSION IS UNCONTROLLED IN P AND BEYOND DIMENSION K MINIMUM.

| DIM | INCHES | | MILLIMETERS | |
|-----|--------|-------|-------------|-------|
| | MIN | MAX | MIN | MAX |
| A | 0.175 | 0.205 | 4.45 | 5.20 |
| B | 0.170 | 0.210 | 4.32 | 5.33 |
| C | 0.125 | 0.165 | 3.18 | 4.19 |
| D | 0.016 | 0.021 | 0.407 | 0.533 |
| G | 0.045 | 0.055 | 1.15 | 1.39 |
| H | 0.095 | 0.105 | 2.42 | 2.66 |
| J | 0.015 | 0.020 | 0.39 | 0.50 |
| K | 0.500 | --- | 12.70 | --- |
| L | 0.250 | --- | 6.35 | --- |
| N | 0.080 | 0.105 | 2.04 | 2.66 |
| P | --- | 0.100 | --- | 2.54 |
| R | 0.115 | --- | 2.93 | --- |
| V | 0.135 | --- | 3.43 | --- |

STYLE 22:

- PIN 1. SOURCE
2. GATE
3. DRAIN

STYLE 23:

- PIN 1. GATE
2. SOURCE
3. DRAIN

Notes

ON Semiconductor and  are trademarks of Semiconductor Components Industries, LLC (SCILLC). SCILLC reserves the right to make changes without further notice to any products herein. SCILLC makes no warranty, representation or guarantee regarding the suitability of its products for any particular purpose, nor does SCILLC assume any liability arising out of the application or use of any product or circuit, and specifically disclaims any and all liability, including without limitation special, consequential or incidental damages. "Typical" parameters which may be provided in SCILLC data sheets and/or specifications can and do vary in different applications and actual performance may vary over time. All operating parameters, including "Typicals" must be validated for each customer application by customer's technical experts. SCILLC does not convey any license under its patent rights nor the rights of others. SCILLC products are not designed, intended, or authorized for use as components in systems intended for surgical implant into the body, or other applications intended to support or sustain life, or for any other application in which the failure of the SCILLC product could create a situation where personal injury or death may occur. Should Buyer purchase or use SCILLC products for any such unintended or unauthorized application, Buyer shall indemnify and hold SCILLC and its officers, employees, subsidiaries, affiliates, and distributors harmless against all claims, costs, damages, and expenses, and reasonable attorney fees arising out of, directly or indirectly, any claim of personal injury or death associated with such unintended or unauthorized use, even if such claim alleges that SCILLC was negligent regarding the design or manufacture of the part. SCILLC is an Equal Opportunity/Affirmative Action Employer.

PUBLICATION ORDERING INFORMATION

Literature Fulfillment:

Literature Distribution Center for ON Semiconductor
P.O. Box 5163, Denver, Colorado 80217 USA
Phone: 303-675-2175 or 800-344-3860 Toll Free USA/Canada
Fax: 303-675-2176 or 800-344-3867 Toll Free USA/Canada
Email: ONlit@hibbertco.com

N. American Technical Support: 800-282-9855 Toll Free USA/Canada

JAPAN: ON Semiconductor, Japan Customer Focus Center
4-32-1 Nishi-Gotanda, Shinagawa-ku, Tokyo, Japan 141-0031
Phone: 81-3-5740-2700
Email: r14525@onsemi.com

ON Semiconductor Website: <http://onsemi.com>

For additional information, please contact your local Sales Representative.